

WS Series Electric Pedestrian Stacker

with capacity of 1,500kg



ZHEJIANG HANGCHA IMP. & EXP. CO., LTD.

Factory site: 666 Xiangfu Road,
Hangzhou, Zhejiang, China (311305)

Tel: +86-571-88926735 88926755
Fax: +86-571-88926789 88132890

sales@hcforklift.com
www.hcforklift.com



Follow us on
Facebook



Follow us on
YouTube



Follow us on
WeChat



Download "Hangcha
Forklift" App



ISO45001
ISO45001:2018



ISO14001
ISO14001:2015



ISO9001
ISO9001:2015



HANGCHA trucks conform
to the European Safety
Requirements.

2023 VERSION 1 / COPYRIGHT 2023 / 10

HANGCHA GROUP CO., LTD. reserves the right to make any changes without notice concerning colors, equipment, or specifications detailed in this brochure, or to discontinue individual models. The colors of trucks, delivered may differ slightly from those in brochures.

The World of Hangcha



WS Series

Electric Pedestrian Stacker



Variable Speed Control



Intelligent & Efficient



Rugged & Durable



Easy & Comfortable



Variable Speed Control on Lifting & Lowering

- Comfortable and efficient thanks to Hangcha patented intelligent handle and control system, ideal for replacing manual & semi-electric stackers, for light use in narrow warehouse environments with efficient and easy pallet stacking.
- The proportional lowering brings high efficiency for exact pallet placement and more precise control when compared to the normal fixed speed of lifting & lowering.
- Variable speed control by proportional control knob, keeps lifting and lowering smooth, stable, safe and energy saving.

BEFORE



FIXED SPEED

NEW



VARIABLE SPEED

LIFT
LOWER

Precise Control

Proportional lifting & lowering

The variable speed control ensures the stacker goes up and down smoothly, minimizing the mechanical shock and vibration, ensuring fragile loads are gently placed on racking or the floor, and reducing the impact of noise and vibration on operators.

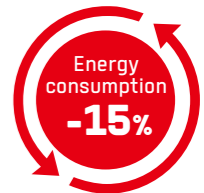

High efficiency

The variable speed control brings accurate response for adjusting the lifting & lowering speed according to the actual situation, the operator can easily complete the task and improve the working efficiency.

Lowering buffering

Automatic lowering speed descent with soft buffering when the fork height is lowered to around 10cm from the ground, effectively protects the safety of the cargo, low noise and small vibration.

Longer service life

Variable speed control can reduce the mechanical impact and friction during lifting & lowering, reduce the wear and tear on the chassis, mast, bearings, and enable a longer service life.

Energy saving

Compared to the traditional fixed lifting & lowering speed, variable speed can be adjusted according to the load and height by operator, reducing energy waste and improving energy utilization rate.

Intelligent & Efficient

Hangcha patented multifunctional intelligent tiller handle is unique design for quick fault diagnosis, enabling an easier service, shorter service time and lowered labor costs.



Multifunctional intelligent tiller handle

- 1 Emergency reverse switch
- 2 Forward and backward control knob
- 3 Horn
- 4 Battery power
- 5 Recharging Alert
- 6 Lifting & Lowering
- 7 Fault code display



Easy Maintenance



Serial communication technology

Single wiring harness communication from tiller handle to controller system. Simple, Durable and Stable.

- Low after-sales service cost
- Quick & easy fault diagnosis
- Everyone can be an expert

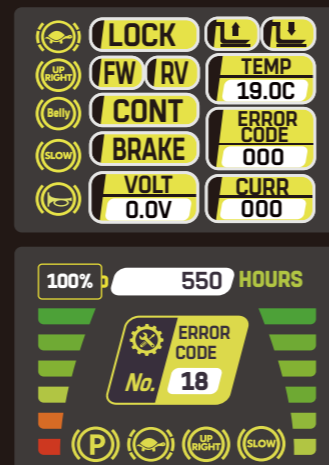

Operation status & fault diagnosis are integrated onto the tiller handle display for easy troubleshooting.

Operator Preferred

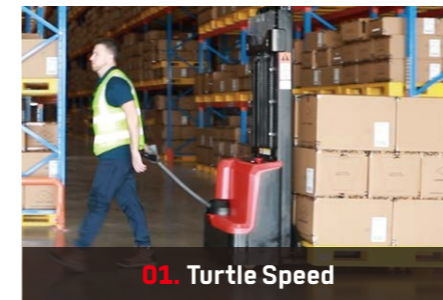

Enable operator to choose different speed modes based on their experience and the specific work environment.

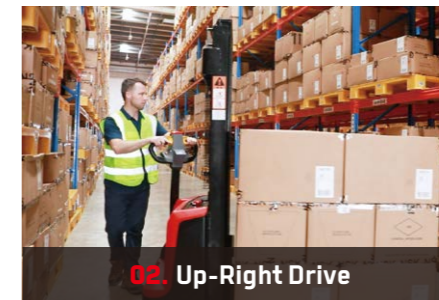

Easily maneuvered with the handle in the vertical position by pressing the turtle-speed button.

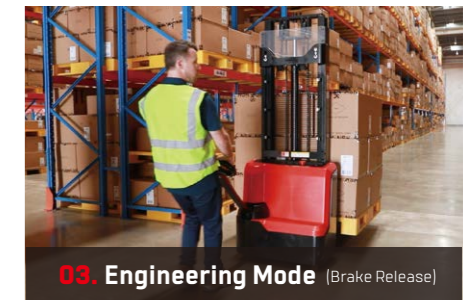

When truck is down, release the brake to move the unit manually.

Rugged & Durable

Due to a high-strength frame and mast design and solid materials used, the deformation of the frame, mast, and forks is small.



Longer service life

Mast: Standard C+H channel steel
Frame: Steel plate thickness of 5mm
Frame bottom plate: 30mm integrated steel plate

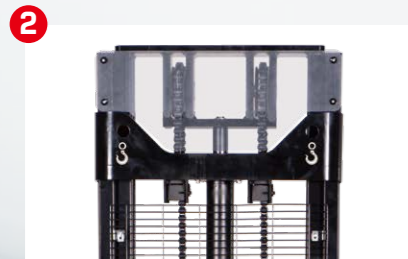

Double-chain design

Compared with single-chain design, it has higher strength, safer and more stable.



Built-in charger

Hidden charging plug, high safety, the whole vehicle is powered off during charging, reducing safety hazards.



Small deformation of forks and masts, stable and durable

More stable when lifting & lowering with loads.

Standard equipped with cylinder explosion-proof valve

It can prevent accidents such as uncontrolled descent caused by unexpected rupture of oil pipes, ensuring stable descent of the load and personal safety, and preventing damage to equipment.



High-strength forks

The forks are formed in one piece with a thickness of 8mm steel. High strength and small deformation even under heavy loads.

The battery is fixed at the bottom of the frame

Improved stability.

Battery low voltage protection

Effectively avoid battery over-discharge, ensuring a longer battery life.

Adjustable balance wheel

Improved stability and maneuverability, suitable for different working scenarios.

High lateral and longitudinal stability

Wider wheelbase and longer axle distance.

Safe operation

Emergency reverse switch

In case of an emergency, it protects the operator and the surrounding personnel from harm.

Safety travel speed limit

When the fork is lifted to above 500mm, the driving speed automatically reduces to 2km/h to ensure the safety of operating at a high position in case of any misoperation.

The low ground clearance of 30mm helps to reduce the risk of foot injuries

Easy & Comfortable



Effortless, easy to operate

Low-mounted longer tiller reduces steering force required.

Low mast static height

Easy to operate in containers and elevators with less than 3.3m lifting height.



Easy to recharge

Built-in charger and an external charging cable storage box for convenient charging.

Longer operating time

Standard 24V/71Ah maintenance-free lead-acid battery, with the option of a larger capacity maintenance-free battery or a lithium battery.



The steering angle is designed to be above 180 degrees

Small turning radius.

Excellent maneuverability

Precise and maneuverable operating, high safety and efficiency.

Reasonable design of the balancing wheel eccentric distance.

Flexible direction commutation.

Optional Configuration

- **Reversing buzzer**
- **Intelligent control**

Unique in the market and very suitable for sorting operations on trucks. With a dedicated remote control device, the operator can control the forks to lift to the appropriate working height and carry out sorting operations, thus avoiding the need to use the handle buttons and bend over to pick up goods, improving operational efficiency and comfort.

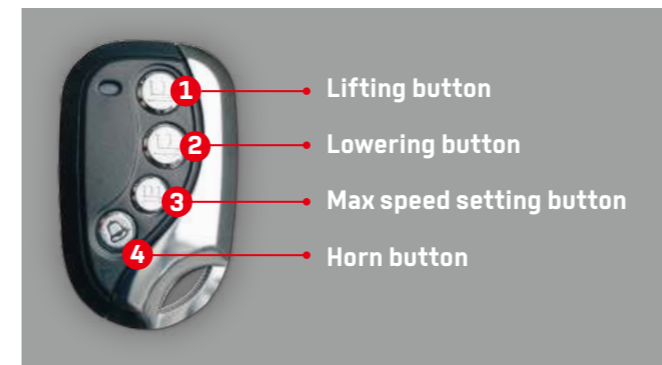

With the remote control device, you can easily set the speed suitable for the work, from level 1 speed to level 5 speed. Such speed transitions allow you to move the truck with controlled operation at ease.



WS Electric Pedestrian Stacker Specification

Distinguishing mark		HANGCHA GROUP CO., LTD.						
1.1	Manufacturer	HANGCHA GROUP CO., LTD.						
1.2	Manufacturer's type designation	CDD15-WS						
1.3	Drive	Battery						
1.4	Operator type	Pedestrian						
1.5	Load capacity/rated load	0	kg	1500				
1.6	Load centre distance	c	mm	500				
1.8	Load distance, centre of drive axle to fork	x	mm	796				
1.9	Wheelbase	y	mm	1204				
Weight								
2.1	Service weight (without battery)		kg	496.4	513.4	523.4	541.4	545.4
2.2	Service weight (with 71Ah battery)		kg	543	560	570	588	592
2.3	Service weight (with 89Ah battery)		kg	548	565	575	593	597
2.4	Axle loading, laden front/rear		kg	603/1409				
2.5	Axle loading, unladen front/rear		kg	384/129				
Tyres, chassis								
3.1	Wheels			Polyurethane				
3.2	Wheel size, front	∅ x width	mm	∅210x70				
3.3	Wheel size, rear	∅ x width	mm	∅80x70				
3.4	Additional wheels (dimensions)	∅ x width	mm	∅115x55				
3.5	Wheels, number front/rear (x = driven wheels)			1 x 1 / 4				
3.6	Tread, front	b10	mm	550				
3.7	Tread, rear	b11	mm	525				
Dimensions								
4.2	Lowered mast height	h1	mm	1480	1730	1980	2130	2230
4.4	Lift height	h3	mm	2000	2500	3000	3300	3500
4.5	Extended mast height	h4	mm	2435	2935	3435	3735	3935
4.9	Height of tiller in driving position, min./max.	h14	mm	692/1255				
4.15	Height, lowered	h13	mm	95				
4.19	Overall length	l1	mm	1710				
4.20	Length to face of forks	l2	mm	561.5				
4.21	Overall width	b1	mm	820				
4.22	Fork dimensions	s/e/l	mm	70x160x1150				
4.25	Width over forks	b5	b5[mm]	560/680				
4.32	Ground clearance, centre of wheelbase	m2	m2[mm]	20				
4.34.1	Aisle width for pallets 1000 - 1200 crossways	Ast	Ast[mm]	1997				
4.34.2	Aisle width for pallets 800 - 1200 lengthways	Ast	Ast[mm]	1952				
4.35	Turning radius	Wa	Wa[mm]	1490				
Performance data								
5.1	Travel speed, with/without load		km/h	4/4.5				
5.2	Lift speed, with/without load		mm/s	0-85 / 0-130				
5.3	Lowering speed, with/without load		mm/s	27.8-137 / 22.5-167				
5.8	Max. gradeability, with/without load		%	5/15				
5.10	Service brake			Electromagnetic				
Electric-engine								
6.1	Drive motor rating S2 60 min		kW	0.75				
6.2	Lift motor rating at S3 15%		kW	2.2				
6.4	Battery voltage/nominal capacity (C5)		V/Ah	● 12/71 x 2 ○ (12/89) x 2				
6.5	Battery weight +/- 5%		kg	● 23.2 x 2(71Ah) / ○ 25.8 x 2(89Ah)				
6.6	Energy consumption according to EN 16796		kWh	0.45				
Additional Data								
8.1	Type of drive control			DC speed control				
8.4	Sound level at the driver's ear according to EN 12053		dB(A)	<75				

Note: 1kgs=2.2lbs, 25.4mm=1inch
 ● standard ○ option

Mast Dimensions

CDD15-WS								
Duplex Mast	h1	Lowered mast height	mm	1480	1730	1980	2130	2230
	h3	Lift height	mm	2000	2500	3000	3300	3500
	h4	Extended mast height	mm	2435	2935	3435	3735	3935

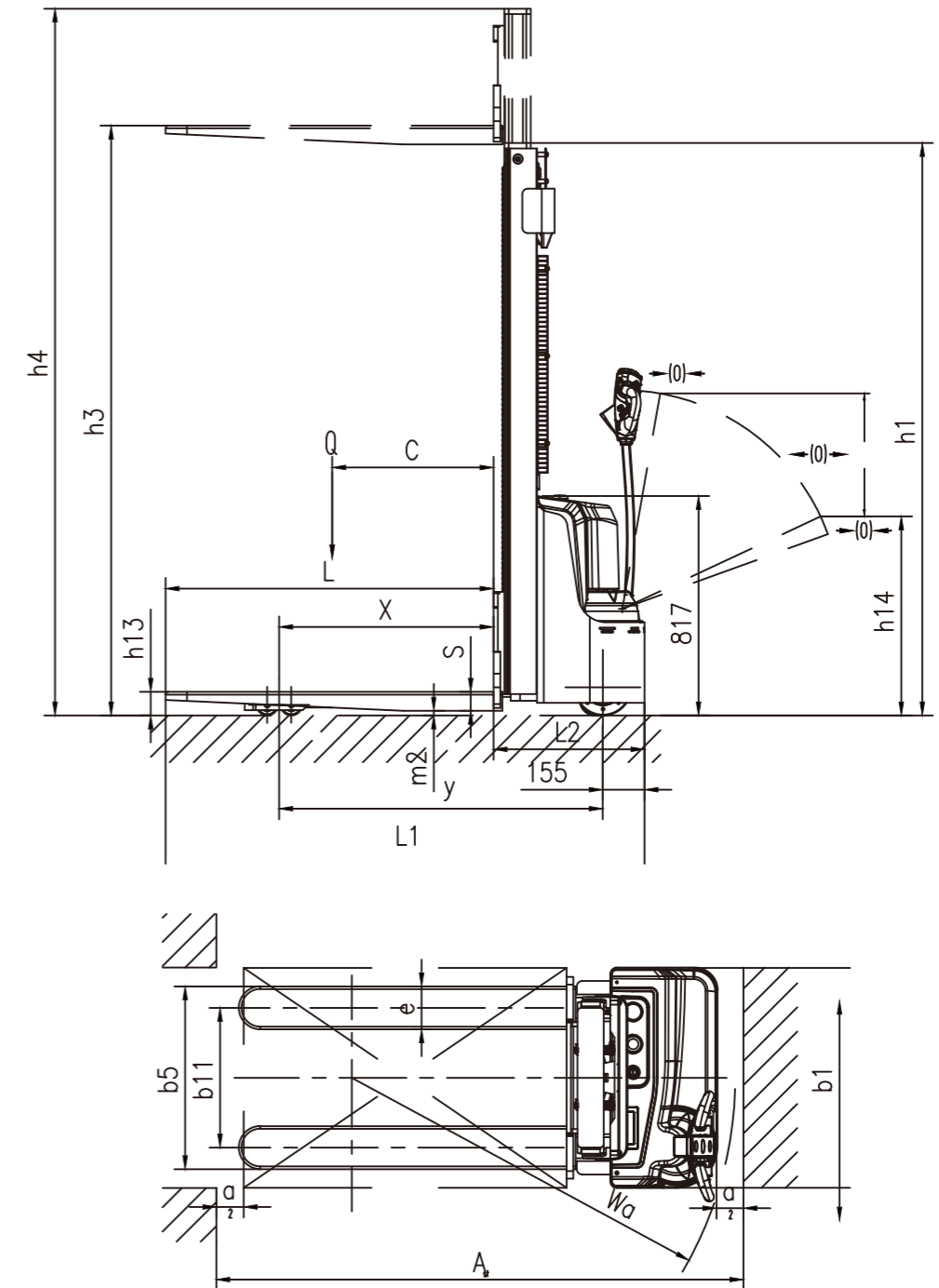

LOAD CHART

